

GRAMERCY HANDLESET WITH L030 KNURLED LEVER

ESTATE PORTFOLIO

























Model Number:
85317.056.RENT

Key Features

- ✓ The Gramercy Knurled Entrance Trim features clean lines and a modern aesthetic design which is perfect for the front door of your home
- ✓ Solid forged brass handleset; deadbolt is furnished with a high grade steel strike for ultimate strength and durability
- ✓ Accommodates door thickness of 1.75. Conversion kit available for 2.0 and 2.25 thick doors
- ✓ Designed for easy installation in standard pre-bored wood and metal doors



FINISHES OPTIONS

 Lifetime (PVD) Satin Nickel - 056	 <i>Lifetime (PVD) Graphite Nickel - 076</i>	 <i>Lifetime (PVD) Polished Nickel - 055</i>	 <i>Polished Chrome - 260</i>	 <i>Distressed Oil Rubbed Bronze - 402</i>	 <i>Lifetime (PVD) Polished Brass - 003</i>	 <i>Lifetime (PVD) Satin Brass - 044</i>	 <i>Polished Nickel & Satin Nickel - M10</i>	 <i>Satin Black - 190</i>	 <i>Oil Rubbed Bronze - 102</i>	 <i>Venetian Bronze - 112</i>
 <i>Satin Brass & Brown - 060</i>	 <i>Non-lacquered Brass - 031</i>	 <i>Vintage Brass - 033</i>	 <i>Polished Nickel & Satin Black - M01</i>	 <i>Satin Black & Polished Nickel - M02</i>	 <i>Non-lacquered Brass & Satin Black - M08</i>	 <i>Satin Black & Non-lacquered Brass - M07</i>	 <i>Satin Black & Satin Brass - M04</i>	 <i>Satin Black & Satin Nickel - M06</i>	 <i>Satin Brass & Black - 050</i>	 <i>Satin Brass & Satin Black - M03</i>
 <i>Satin Nickel & Polished Nickel - M09</i>	 <i>Satin Nickel & Satin Black - M05</i>									

all measurements in inches

SPECIFICATIONS

STYLE	Contemporary
LOCK FUNCTION	Entry
BACKSET SIZE	Adjustable
LATCH TO THROUGH-BOLT HEIGHT	14 9/32
ENTRY NUMBER OF CYLINDERS	1,0
CROSS BORE	2-1/8"

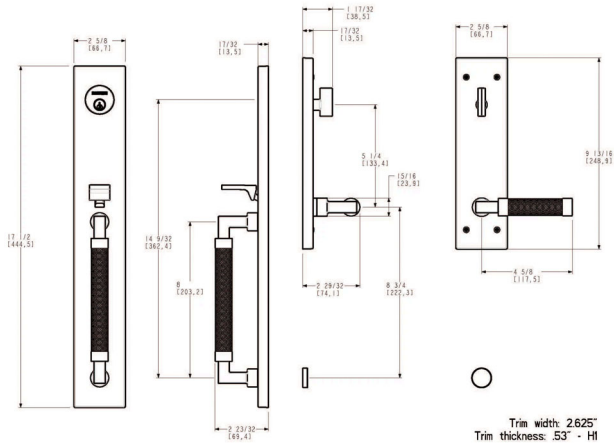

18761 Da Vinci • Lake Forest • California • 82810 • 1.800.566.1986 • BaldwinHardware.com • 613883S